

Artistry in Sound
ONKYO[®]

A-809/807

Integrated Stereo Amplifier

Instruction Manual

- *Congratulations on your purchase of the ONKYO A-809/807 Integrated Amplifier.*
- *Please read this manual thoroughly before making connections and turning power on.*
- *Following the instructions in this manual will enable you to obtain optimum performance and listening enjoyment from your new A-809/807.*
- *Please retain this manual for future reference.*

CONTENTS

Features	1
Important safeguards.....	2
Precautions.....	2
System connections	3
Front panel facilities.....	5
Operations.....	7
Using the remote control transmitter.....	9
Troubleshooting guide.....	10
Specifications	10

Features

• Simple and Direct Signal Paths

To keep the signal paths as short and direct as possible, all audio signals can be routed right into the power amplifier block via a separate volume control. All you need do to use this simplified signal path is to set the SOURCE DIRECT switch to DIRECT. If tone compensation is necessary, the switch can be set to TONE to route the music signal through the direct tone circuitry. It is also possible to monitor the recorded signal when recording using TAPE-1 or TAPE-2.

• High Quality Remote Control System

The A-809 and A-807 let you operate the input selector, muting switch and volume control of the amplifier by remote control without in any way diminishing the sonic purity of the music signal. The high quality system uses motors to drive the volume control and input selector. The mechanical rotary switches used for the Input selector are free of the non-linearity to which conventional semiconductor switches are susceptible. Clip-type contacts assure sure, reliable operation. ONKYO's high quality remote control system provides ease of use while assuring the utmost in audio fidelity.

• ONKYO Exclusive AEI Transformer

ONKYO's AEI (Anti-Electromagnetic Interference) transformer is designed to reduce distortion causing magnetic flux leakage. It boasts a special core configuration and silicon steel shielding that results in a reduction in flux leakage to 1/10 — 1/20 the levels associated with conventional EI transformers. During heavy loads, the AEI transformer produces even less magnetic flux than more expensive toroidal units. The result is lower distortion levels for purer, more musical sound.

• Discrete Power Supplies and Sub-Transformers for Principal Circuit Blocks

• Dual Shielded Block Construction with Two-Panel Chassis Base

The power supply block is housed separately from the block containing other amp stages in its own specially shielded enclosure. There are even separate base panels for the two blocks. In addition the massive heat sink serves as a barrier between the power stage and the circuitry which handles low level signals, effectively shutting out interference. This helps prevent distortion and assures that top signal purity is maintained.

• Opto-Drive Power Amplifier Circuitry (A-809)

• Rigid Chassis Construction to Shut Out Vibrations

• Strictly Selected Parts Including Large Twin-Rolled Chemical Capacitors

• Charging Noise Filter

• Heavy Duty Four-Way Speaker Terminals

CAUTION

"TO REDUCE THE RISK OF ELECTRIC SHOCK, DO NOT REMOVE COVER (OR BACK). NO USER-SERVICEABLE PARTS INSIDE. REFER SERVICING TO QUALIFIED SERVICE PERSONNEL."



- The lightning flash with arrowhead symbol, within an equilateral triangle, is intended to alert the user to the presence of uninsulated "dangerous voltage" within the product's enclosure that may be of sufficient magnitude to constitute a risk of electric shock to persons.



- The exclamation point within an equilateral triangle is intended to alert the user to the presence of important operating and maintenance (servicing) instructions in the literature accompanying the appliance.

"WARNING"

"TO REDUCE THE RISK OF FIRE OR ELECTRIC SHOCK, DO NOT EXPOSE THIS APPLIANCE TO RAIN OR MOISTURE."

- For models having power cords with a polarized plug.

CAUTION: TO PREVENT ELECTRIC SHOCK DO NOT USE THIS (POLARIZED) PLUG WITH AN EXTENSION CORD, RECEPTACLE OR OTHER OUTLET UNLESS THE BLADES CAN BE FULLY INSERTED TO PREVENT BLADE EXPOSURE.

- Sur les modèles dont la fiche est polarisée.

ATTENTION: POUR PRÉVENIR LES CHOCS ÉLECTRIQUES NE PAS UTILISER CETTE FICHE POLARISÉE AVEC UN PROLONGATEUR, UNE PRISE DE COURANT OU UNE AUTRE SORTIE DE COURANT, SAUF SI LES LAMES PEUVENT ÊTRE INSÉRÉES À FOND SANS EN LAISSER AUCUNE PARTIE À DÉCOUVERT.

Important safeguards

1. **Read Instructions** – All the safety and operating instructions should be read before the appliance is operated.
 2. **Retain Instructions** – The safety and operating instructions should be retained for future reference.
 3. **Heed Warnings** – All warnings on the appliance and in the operating instructions should be adhered to.
 4. **Follow Instructions** – All operating and use instructions should be followed.
 5. **Water and Moisture** – The appliance should not be used near water – for example, near a bathtub, washbowl, kitchen sink, laundry tub, in a wet basement, or near a swimming pool, and the like.
 6. **Carts and Stands** – The appliance should be used only with a cart or stand that is recommended by the manufacturer.
- 6A. An appliance and cart combination should be moved with care. Quick stops, excessive force, and uneven surfaces may cause the appliance and cart combination to overturn.



7. **Wall or Ceiling Mounting** – The appliance should be mounted to a wall or ceiling only as recommended by the manufacturer.
8. **Ventilation** – The appliance should be situated so that its location or position does not interfere with its proper ventilation. For example, the appliance should not be situated on a bed, sofa, rug, or similar surface that may block the ventilation openings; or, placed in a built-in installation, such as a bookcase or cabinet that may impede the flow of air through the ventilation openings.
9. **Heat** – The appliance should be situated away from heat sources such as radiators, heat registers, stoves, or other appliances (including amplifiers) that produce heat.
10. **Power Sources** – The appliance should be connected to a power supply only of the type described in the operating instructions or as marked on the appliance.
11. **Polarization** – If the appliance is provided a polarized plug having on blade wider than the other, please read the following information: The polarization of the plug is a safety feature. The polarized plug will only fit the outlet one way. If the plug does not fit fully into the outlet, try reversing it. If there is still trouble, the user should seek the services of a qualified electrician. Under no circumstances should the user attempt to defeat the polarization of the plug.
12. **Power-Cord Protection** – Power-supply cords should be routed so that they are not likely to be walked on or pinched by items placed upon or against them, paying particular attention to cords at plugs, convenience receptacles, and the point where they exit from the appliance.
13. **Cleaning** – The appliance should be cleaned only as recommended by the manufacturer.
14. **Nonuse Periods** – The power cord of the appliance should be unplugged from the outlet when left unused for a long period of time.
15. **Object and Liquid Entry** – Care should be taken so that objects do not fall and liquids are not spilled into the enclosure through openings.
16. **Damage Requiring Service** – The appliance should be serviced by qualified service personnel when:
 - A. The power-supply cord or the plug has been damaged; or
 - B. Objects have fallen, or liquid has been spilled into the appliance; or
 - C. The appliance has been exposed to rain; or
 - D. The appliance does not appear to operate normally or exhibits a marked change in performance; or
 - E. The appliance has been dropped or the enclosure damaged.
17. **Servicing** – The user should not attempt to service the appliance beyond that described in the operating instructions. All other servicing should be referred to qualified service personnel.

Precautions

1. **Warranty Card**

The serial number is written on the rear panel of this unit. Copy the serial number and model number onto your warranty card and keep it in a safe place.
2. **Recording Copyright**

Recording of copyrighted material for other than personal use is illegal without permission of the copyright holder.
3. **AC Fuse**

The fuse is located inside the chassis and is not user serviceable. If power does not come on, contact your ONKYO authorized service center.
4. **Care**

From time to time you should wipe off the front and rear panels and the cabinet with a soft cloth. For heavier dirt, dampen a soft cloth in a weak solution of mild detergent and water, wring it out dry, and wipe off the dirt. Following this, dry immediately with a clean cloth. Do not use rough material, thinners, alcohol or other chemical solvents or cloths since these could damage the finish or remove the panel lettering.
5. **Power WARNING**

BEFORE TURNING ON POWER FOR THE FIRST TIME, READ THE FOLLOWING SECTION CAREFULLY.

 - Some models are designed for use only with the power supply voltage of the region where they are sold.

USA & Canadian models: AC120V, 60Hz

System connections

Do not plug in the power cord until all connections have been made.

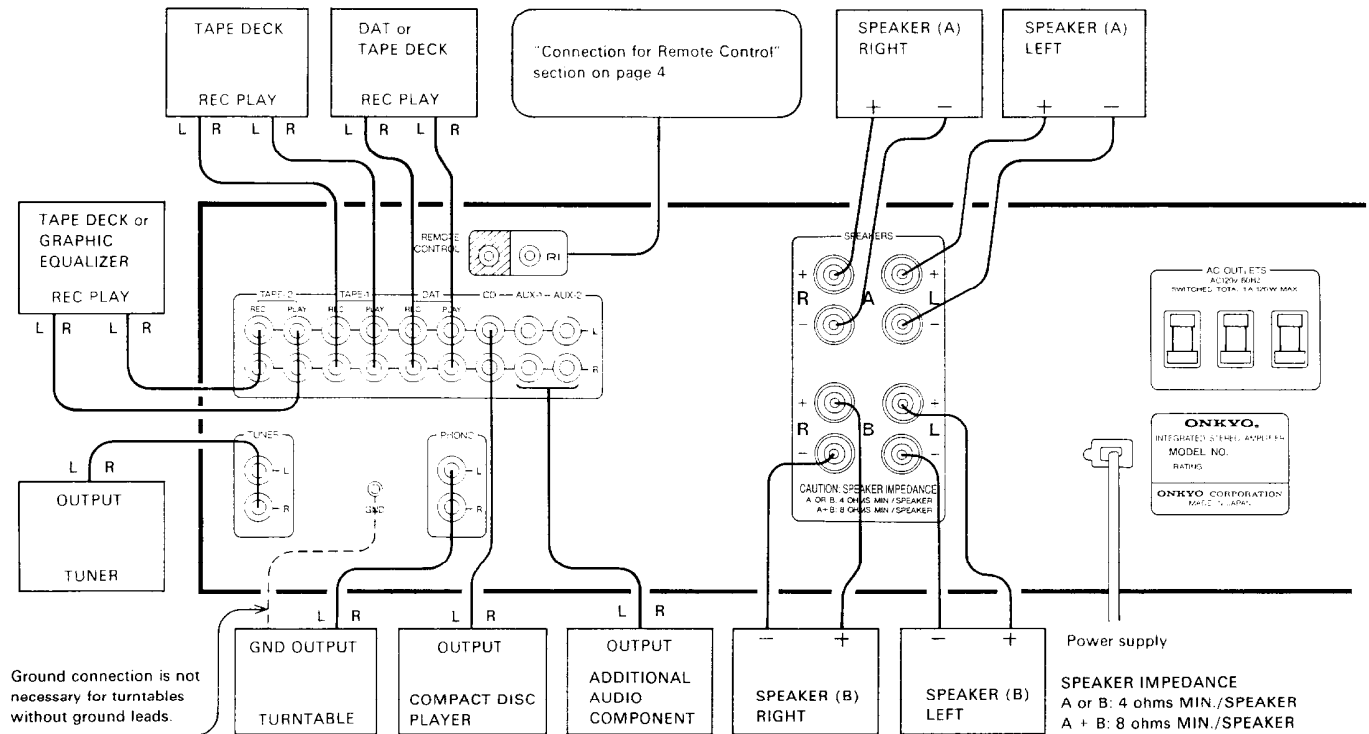

General

On each pair of input or output jacks, the lower jack (marked R) corresponds to the right channel, and the upper jack (marked L) to the left channel. When jacks on other equipment or connection cables are color-coded, the color red usually corresponds to the right channel (Red = Right).

Turntable Connections

Be sure to connect the ground (earth) lead wire from the turntable to the ground terminal (GND). Lack of proper ground connection will cause hum. Also observe the following precautions.

- Place the turntable on a firm shelf or desk free from vibrations (especially those generated by the speaker systems). If the turntable is permitted to pick up such vibrations, not only will this unit's performance suffer, but distortion in the bass range and howling noise in the speakers may also occur.
- Check the turntable instruction manual for any other precautions.
- The loud noises that occur when connecting and disconnecting the turntable leads could damage the speakers. Always turn the power switch off before making connections.

Compact Disc Player Connections

Connect a compact disc player to the CD input jacks. Be sure the left and right channels are connected properly.

Tuner Connections

Connect an FM/AM tuner to the tuner input jacks. Be sure the left and right channels are connected properly.

Tape Deck Connections

Three tape decks can be connected at once to this unit. "DAT" jacks can also be used for tape deck connections. Connect the tape deck output leads to the PLAY jacks and the tape deck input leads to the REC jacks of this unit. For more details, refer to your tape deck owner's manual. VCR sound input/output can also be connected.

Speaker Connections

When connecting speakers, proper polarity is important. Always connect the (+) terminal (red) on the amplifier to the (+) terminal on the speaker and the (-) terminal (black) on the amplifier to the (-) terminal on the speaker. Two separate pairs of speaker systems can be connected to this unit at once.

- The load impedance of each speaker system connected to this unit must be at least 4 ohms. (A or B-4 ohms min., A and B-8 ohms min.)
- When using only one speaker or when you wish to listen to monaural, the single speaker should never be connected in parallel to both the right and left channel terminals at once.

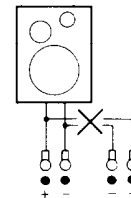

- Do not use unnecessarily long or extremely thin speaker leads. If the DC resistance of the speaker leads is too high, the damping factor will decrease.

Connecting Speaker Cables

1. Remove about 1/3 inch of insulation from the end of the speaker cable.
2. Twist the exposed copper strands together tightly.
3. Unscrew the speaker terminal part way by turning it counter-clockwise.
4. Insert the exposed copper portion of the cable all the way into the opening in the speaker terminal.
5. Tighten the terminal screw by turning it clockwise.
6. Check to make sure that none of the uninsulated copper portion of the cable is exposed.

CAUTION:

When using banana plugs, make sure the speaker terminal screws are screwed in firmly before inserting banana plugs.

Mixing Console or Graphic Equalizer Connections

A mixing console or graphic equalizer can be connected to the TAPE-2 jack as shown in the diagram.

AC Outlets

● SWITCHED:

These outlets are switched on and off by the POWER button on the front panel and remote control transmitter. Capacity is total 1A 120 watts MAX.

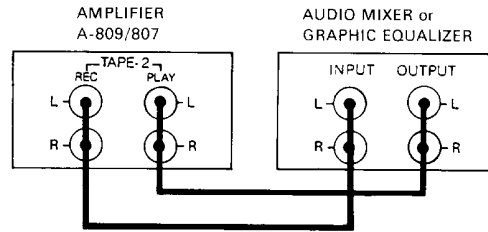

Connections for Remote Control (REMOTE CONTROL)

NOTE:

Of the ONKYO tuners, turntables, cassette decks, CD players, etc. that can be remote controlled, some models have the **RI** mark and some do not. (**RI** : Remote Interactive)

A tuner, cassette tape deck, compact disc player and turntable that have the ONKYO **RI** mark can be operated, using the accessory remote control transmitter.

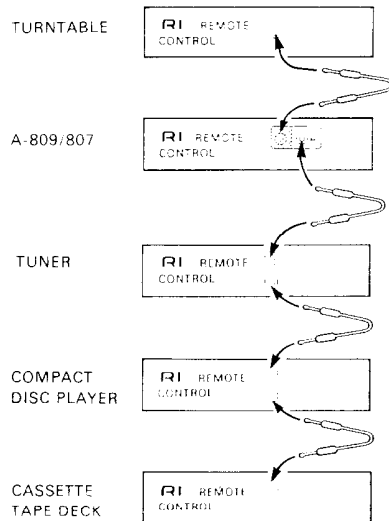

An **RI** remote control cable equipped with a 1/8" (3.5mm) diameter miniature two-conductor phone plug is attached to the A-809/807 and to any turntable, tuner, or compact disc player, with the **RI** mark.

Insert the accessory **RI** remote control cable plug attached to the ONKYO turntable with the **RI** mark into the PHONO of the A-809/807's REMOTE CONTROL. To use an ONKYO compact disc player and cassette tape deck and tuner with the **RI** mark, insert the accessory remote control cable plug into the REMOTE CONTROL jacks. As far as connecting sequence is concerned, it doesn't matter whether the cable is connected from the A-809/807 to tuner or to the cassette tape deck or to the compact disc player. The connecting sequence is fixed only for the turntable. The remote control transmitter is operated by facing it towards the remote control sensor of the A-809/807.

- ONKYO turntables that can be remote controlled but do not have the **RI** mark. This equipment has a 7-pin DIN jack on the rear panel. Connect this jack and the jack on the rear of the A-809/807 with the special cable for this purpose, which is sold separately.

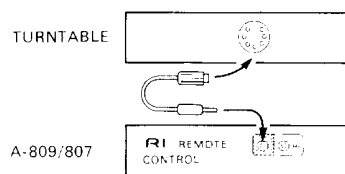

For this special cable, contact an ONKYO Service Center.

For a turntable (3.5 mm pin to 7-pin plug cable) part number: 2010140

NOTE:

Remote control operation is not possible when only the remote control cable is connected. Remote control cable and pin cord must be connected.

Front panel facilities

- Front panel description of A-809/807.

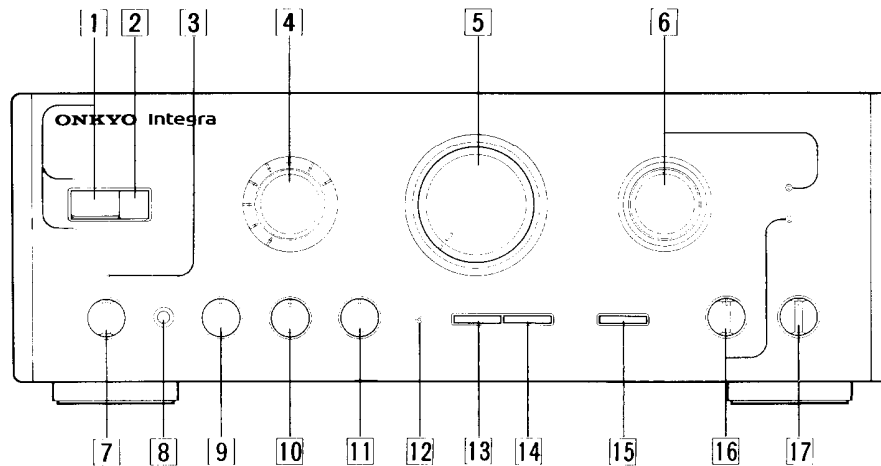

- 1 Power Button (POWER) and Indicator**
Press the POWER button to turn on the power.
Press this button to switch the on/off status of the power supply and the AC outlets on the rear panel. Power can also be turned on by using the remote control POWER button. When the power button is in the off position, the STAND BY indicator will illuminate.
- 2 Remote Control Sensor**
This receives signals sent from RC-206S remote control transmitter.
- 3 Servo Operation Indicator (SERVO OPERATION)**
A few seconds after the power is turned on, the Servo Operation indicator lights orange to show that the Super Servo circuitry has stabilized. No sound will be heard until this indicator becomes orange. When a problem such as a shorted output terminal circuit occurs during operation, the indicator goes off. Immediately turn the power off and consult an authorized serviceman.
- 4 Input Selector Switch and Indicators (INPUT SELECTOR)**
This switch is used to select the desired program source. The switch can be turned in either direction without end stops. An indicator lights to show which program has been selected. The switch is also able to be switched directly using the Input Selector buttons on the remote control transmitter.
TAPE-2 : Tape deck connected to the TAPE-2 jacks.
TAPE-1 : Tape deck connected to the TAPE-1 jacks.
DAT : Tape deck connected to the DAT jacks.
PHONO : Turntable connected to the PHONO jacks.
TUNER : Tuner connected to the TUNER jacks.
CD : Compact disc player connected to the CD jacks.
AUX-1, 2 : Additional audio component connected to the AUX-1 or 2 jacks.
- 5 Volume Control Knob (VOLUME)**
This controls volume. Turning it clockwise increases volume. When controlling with the remote control transmitter, pressing "UP" or "DOWN" increases or decreases volume respectively. This control employs the system of simultaneous changes in volume and boost characteristics.
- 6 Source Direct Switch (SOURCE DIRECT) and Indicator**
DIRECT : The signal of the source selected with the INPUT SELECTOR switch or remote control transmitter can be input directly into the main amplifier. At this time the signal will bypass the DIRECT TONE, BALANCE, ATTENUATOR, SUBSONIC and MODE circuits and DIRECT indicator will light.
TONE : The DIRECT TONE control, BALANCE, ATTENUATOR, SUBSONIC and MODE of the performance can be altered for the source selected with the INPUT SELECTOR switch, or remote control transmitter.
MONITOR TAPE-1/TAPE-2 : The sound which is being recorded can be monitored, when the three-head tape deck is connected. When this is selected, DIRECT TONE, BALANCE, ATTENUATOR, SUBSONIC and MODE can be effective.
- 7 Speaker Selector Switch (SPEAKERS)**
This unit can drive two different speaker systems at once. Use this selector to activate either or both speaker systems connected to the rear panel speaker terminals. In the OFF position, sound is heard only through the headphones.
OFF : All speakers off—only headphones operate.
A : Speakers A
B : Speakers B
A + B : Both speaker systems A and B.
- 8 Headphone Jack (PHONES)**
Stereo headphones with a standard binaural plug can be connected here.
- 9 Bass Control Knob (BASS)**
Turn right to boost or left to attenuate bass. In the DEFEAT position, the BASS tone control circuitry is completely bypassed.
- 10 Treble Control Knob (TREBLE)**
Turn right to boost or left to attenuate treble. In the DEFEAT position, the TREBLE tone control circuitry is completely bypassed. When turned to the extreme left (-10), the TREBLE control acts as a high cut filter to eliminate scratches, hissing and other high frequency noise.

About the Variable Tone Boosting System

This unit is designed to gradually reduce the effect of the tone controls (BASS and TREBLE) when the VOLUME exceeds a certain level. The variable boosting system gradually reduces the boosting effect of the BASS and TREBLE controls when one or both of these controls is turned beyond (to the right of) the center defeat position and the VOLUME control is turned beyond the center position. When the VOLUME is turned all the way up, the frequency response will be flat again. The VOLUME settings below the center position have no effect on the DIRECT TONE controls. Also, BASS and TREBLE control settings below (to the left of) the center DEFEAT position are not altered by the volume level.

- 11 Balance Control Knob (BALANCE)**
Adjust to control the relative volume level of the left and right speakers or headphones.
- 12 Muting Indicator**
Muting can be performed by the remote control transmitter MUTING-∞ button. When muting is ON, this indicator will light.
- 13 Attenuator Switch (ATTENUATOR)**
When this switch is set to the -20dB position, the volume level is reduced to one-tenth of the level set by the VOLUME control.
- 14 Subsonic Filter Switch (SUBSONIC)**
The subsonic filter cuts off all frequencies below 15Hz thus eliminating motor rumble and other inaudible subsonic frequency noises responsible for distortion in the bass region.

- 15 Mode Selector Switch (MODE)**
STEREO (■) : Position for normal stereo listening.
MONO (▲) : Both right and left channel signals are sent to each speaker. Position for listening to monaural recordings or when adjusting the BALANCE control.
- 16 Recording Source Selector Switch (REC SELECTOR) and Indicator (A-809 only)**
DAT or TAPE can be selected by the REC SELECTOR switch.
TAPE-1 ▶ DAT & TAPE-2, DAT ▶ TAPE-1 & 2
: Use either of these settings for tape dubbing operations depending on which deck is being used for playback and which is being used for recording. For details, refer to the Operations section.
OFF : When not recording or dubbing.
SOURCE: Recording from the source selected by the INPUT SELECTOR switch or remote control transmitter. When the Input Selector switch is set to either Tape-1, Tape-2 or DAT, you cannot record, also for the A-809, the REC SELECTOR indicator will not illuminate.
- 17 Cartridge Selector Switch (CARTRIDGE)**
MC : Turntable using an MC cartridge.
MM : Turntable using an MM cartridge.

Use the MM position when a step-up transformer is being used with a turntable equipped with an MC cartridge.

Remote Control Transmitter

Phono Operation Button (PLAY/REJECT)

This button is used to operate the turntable. The phono operation button can be used only when the PHONO input selector button has been pressed. Each time the phono operation button is pressed, the remote control transmitter alternately emits the play or reject command.

Power Button (POWER)

Input Selector Buttons (TAPE-2, TAPE-1, TUNER, CD, DAT, AUX-2, AUX-1, PHONO)

CD Operation Buttons (CD)

These buttons are used to operate an ONKYO CD player with the **RI** mark.

- : Press this button to pause the CD play back. To resume disc play, press the PLAY (▶) button.
- ▶ : Press this button to play the CD player.
- : Press this button to stop the CD player.
- ◀◀ : Press this button to go back to the beginning of the current track and again to skip back to the previous track.
- ▶▶ : Press this button to skip to the next track.

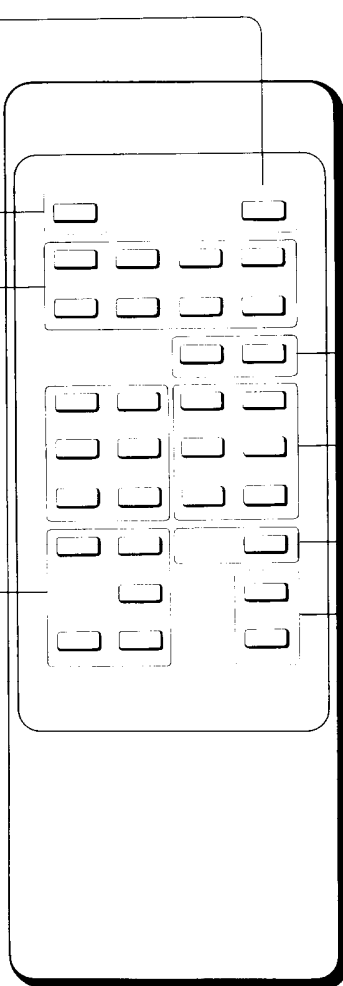

Tuner Operation Buttons (TUNER)

- ◀ PRESET ▶ : Preset memory DOWN/UP buttons

Tape Operation Buttons (DECK-A, DECK-B)

These buttons control ONKYO double cassette tape decks that can be remote controlled. Use the DECK-B buttons to control single cassette tape decks with the **RI** mark.

- ◀ : The tape plays, moving from right to left, or, in the recording stand-by mode, recording begins.
- ▶ : The tape plays, moving from left to right, or, in the recording stand-by mode, recording begins.
- /■ : When this is pressed, the recording stand-by mode is entered.
- : Interrupts all operations.
- ◀◀ : Fast forward from right to left.
- ▶▶ : Fast forward from left to right.

Audio Muting Button (MUTING -∞)

This button temporarily switches off the sound from the speaker or headphone. Pressing this button will operate the A-809/807 audio muting circuit. The audio muting indicator will light. Pressing the button again or using the POWER button to turn the power on will turn off the audio muting.

Volume Buttons (UP, DOWN)

Operations

Connect all components to the rear panel jacks as shown in the system connections section and set the front panel controls at the appropriate setting to hear the desired program source.

Normal Standby Mode

The standby positions of front panel controls and switches serve as the starting point for all operating modes.

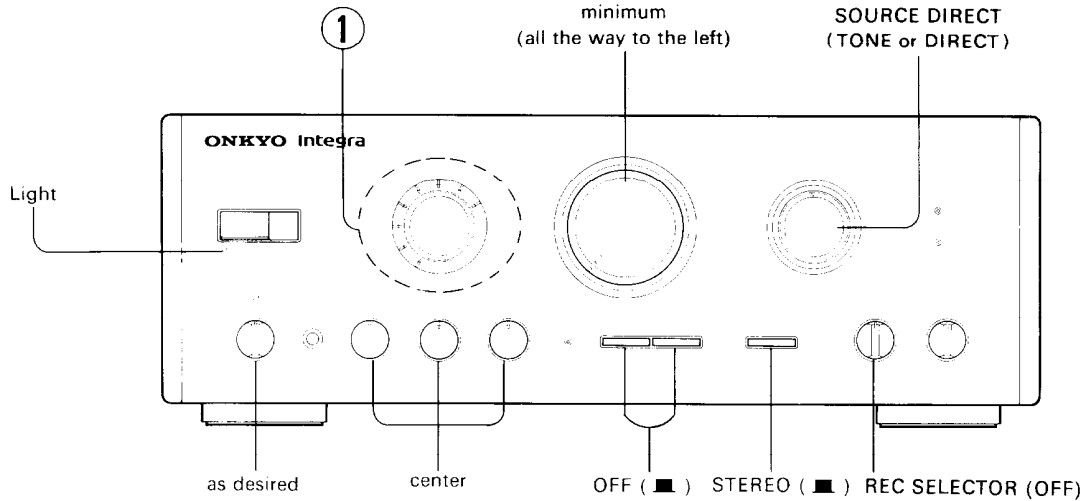

- Press the power button after the above settings have been made.

■ Listening to a broadcast

- ① Turn the Input Selector switch to TUNER.
2. Set the tuner to receive the broadcast that you want to listen to.

■ Listening to a record

- ① Turn the Input Selector switch to PHONO.
2. Set the CARTRIDGE Selector switch to the type of cartridge you are using.

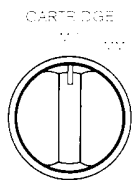

Example:
Using the MC cartridge

3. Set the turntable for playback.

■ Listening to a compact disc

- ① Turn the Input Selector switch to CD.
2. Set the CD player for playback.

■ Listening to the component connected AUX-1 or 2 jacks

- ① Turn the Input Selector switch to AUX-1 or 2.
2. Set the component for playback.

■ Using Tape Decks

Playback:

Three tape decks can be connected to this unit at once. If the deck connected to the DAT jack is to be heard, turn the Input Selector switch to DAT. To listen to the deck connected to the TAPE-1 jack, Turn the Input Selector switch to TAPE-1. In the same way, Turn the Input Selector switch to TAPE-2 to listen to the deck connected to the TAPE-2 jack.

NOTES:

- Rotate the VOLUME control knob slowly to find the optimum volume setting.
- Please refer to pages 5 and 6, "Front panel facilities," and adjust the sound quality to your own satisfaction, using the DIRECT TONE control knobs. If necessary, you can also use the BALANCE control knob and MODE switch for fine tuning.

This unit employs a microcomputer to perform various functions and operations. If interference generated by an external power supply, radio waves, or other electrical sources result in an accident which causes the specified operations and functions to operate abnormally. For example, if an input source is selected, using the Input Selector switch, but no input signal is received the Input Selector indicator will flash after 10 seconds. Disconnect the unit's power cord from the power source, leave for 5 to 15 seconds then re-connect the power cord.

■ **Recording on the Tape Deck or DAT from the Program Source (PHONO, TUNER, CD, AUX-1, AUX-2)**

1. Select the desired recording source with the Input Selector switch. (PHONO, TUNER, CD, AUX-1, AUX-2)
2. Set the SOURCE position of the REC SELECTOR switch.

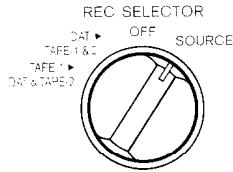

3. Begin tape deck or DAT recording operations.
4. Begin program source performance.
 - * Be careful not to change the INPUT SELECTOR switch while recording.
 - If you are using a three-head tape deck. The sound can be monitored if the SOURCE DIRECT switch is turned to TAPE-1 or TAPE-2 (excluding DAT).
 - Refer to the next section for recording with TAPE-1, TAPE-2 and DAT.

■ **Tape-to-Tape Duplicating**

When two or three tape decks are connected to this unit at the same time, a tape can be copied from one deck to the other.

1. To copy a pre-recorded tape from tape deck 1 (connected to the rear panel DAT jacks) to tape deck 2 (connected to the TAPE-1 jacks) or tape deck 3 (connected to the TAPE-2). Place the REC SELECTOR switch in the DAT ► TAPE-1 & 2 position and put tape deck 1 in the playback mode and tape deck 2 or 3 in the recording mode.

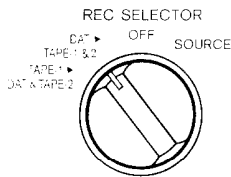

If tape deck 2 or 3 is a 3-head deck, the just-recorded signal can be monitored by turning the TAPE-1 or TAPE-2 Input Selector switch. To monitor the signal from tape deck 1 before it has been recorded, turn to the DAT Input Selector switch. Turn to one of the other Input Selector switches to listen to the CD player, turntable, tuner or auxiliary component while dubbing is taking place.

2. To copy from tape deck 2 (connected to the TAPE-1 jack) to tape deck 1 (connected to the DAT jack) and tape deck 3 (connected to the TAPE-2 jack). Place the REC SELECTOR switch in the TAPE-1 ► DAT & TAPE-2 position and put tape deck 1 or 3 in the recording mode and tape deck 2 in the playback mode.

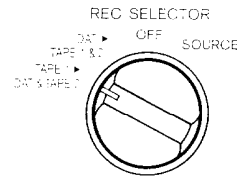

If tape deck 1 or 3 is a 3-head deck, the just-recorded signal can be monitored by turning the DAT or TAPE-2 Input Selector switch. Turn to one of the other Input Selector switches to listen to the CD player, turntable, tuner or auxiliary component while dubbing is taking place.

- Dubbing cannot be done from tape deck 3 (connected to the TAPE-2 jacks) to tape decks 1 or 2 (connected to the DAT or TAPE-1 jacks).

To Equalize an Audio Source for Playback

1. Select the desired listening source with the Input Selector switch (PHONO, TUNER, CD, AUX-1, AUX-2) and set the REC SELECTOR switch to the SOURCE position.

When using an equalizer on the DAT signal, set the REC SELECTOR switch to DAT ► TAPE-1 & 2. When using an equalizer with the deck connected to the TAPE-1 jack, set it to TAPE-1 ► DAT & TAPE-2.

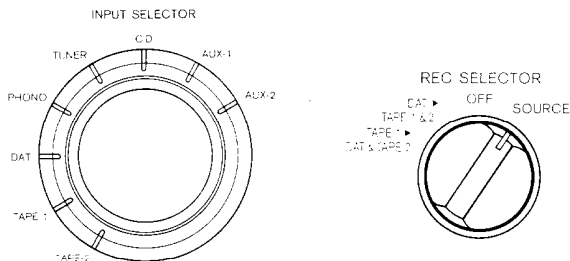

2. Turn to the SOURCE DIRECT switch to MONITOR-TAPE-2.

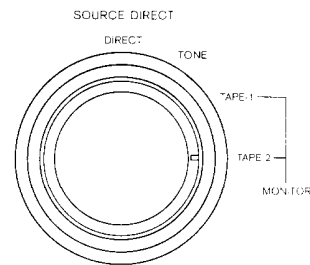

3. Begin performance.
 - DIRECT TONE Control, BALANCE, ATTENUATOR, SUBSONIC and MODE functions can all be adjusted from this unit.

NOTE:

When recording something that has been sent through an equalizer, use an equalizer which is equipped with equalizing recording capacity.

Using the remote control transmitter

1. Remove the batteries if the remote control transmitter is not going to be used for a long time.
2. The batteries of the remote control transmitter must be replaced periodically.
3. This unit uses infrared rays. Therefore, commands may not be received properly if the front panel of this unit is exposed to bright light. To prevent this from occurring, place this unit so that it is not directly exposed to bright light.
4. If this unit is placed inside an audio rack behind a glass door, the door should not have colored glass or have any decorations on it, since this could shorten the range or prevent commands from being received.
5. Use of other infrared remote control devices in the same room may cause interference.
6. The transmitter operates up to a distance of about five meters (16 feet). The transmitting window must always be pointed at the reception window when a command is sent to the A-809/807.
7. If this remote control transmitter does not operate properly, confirm that the batteries are not dead. If the problem persists, contact your ONKYO Service Center.

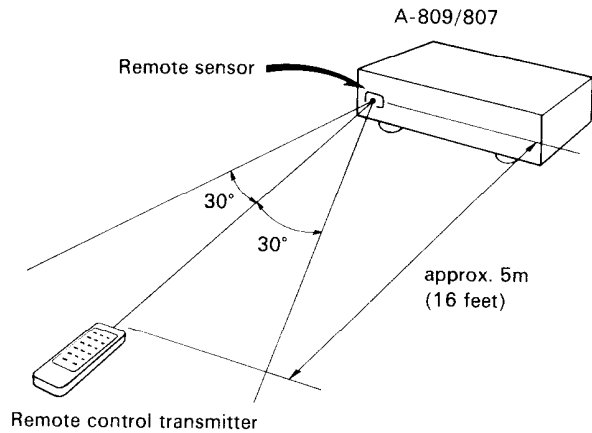

Transmitter Battery Insertion

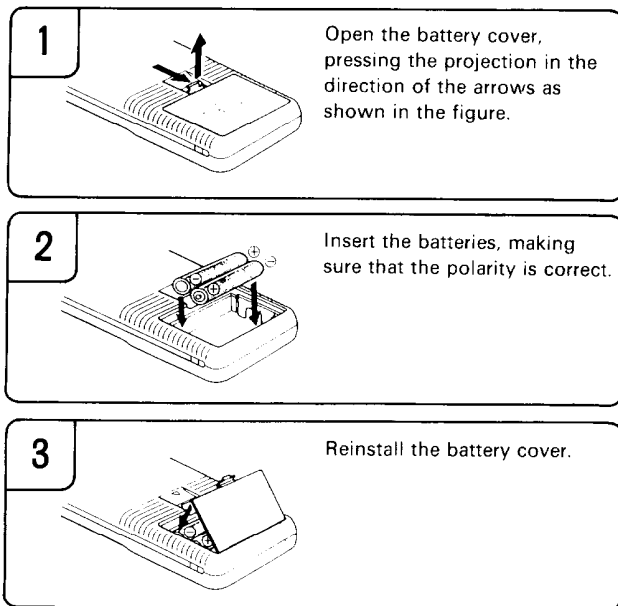

Precautions when using batteries

- The remote control transmitter is powered by two batteries. Before using this unit for the first time, insert the two batteries (included) as shown in the diagram.
- Average battery life is about one year. This period may be shorter depending on the frequency of use and environment (temperature and humidity) in which the remote control transmitter is used.
- If the remote control transmitter does not operate even though front panel controls function normally, the batteries should be replaced. Use only batteries listed in the following chart.

Type	Voltage	Size
Manganese	1.5V	AA R6 UM-3

NOTES:

1. Do not leave an expired battery in the case as it may leak or damage the battery case.
2. When inserting the batteries, be sure the (+) and (-) ends are properly aligned.
3. Do not use nickel-cadmium (rechargeable) batteries.
4. Do not use one specified (manganese) battery and one alkaline Battery at the same time.
5. Replace both batteries at once; do not use one old and one new battery together.

Troubleshooting guide

Trouble	Cause	Remedy
No power.	<ul style="list-style-type: none"> ● The power cord is not plugged in. ● AC fuse blown. 	<ul style="list-style-type: none"> ● Plug in the power cord. ● Contact your authorized ONKYO service center.
Power on but no sound.	<ul style="list-style-type: none"> ● Bad connections. 	<ul style="list-style-type: none"> ● Check input leads, speaker leads, pin plugs, etc.
Hum, low frequency noise.	<ul style="list-style-type: none"> ● Poor or no input ground. ● Poor or no phono motor ground. 	<ul style="list-style-type: none"> ● Check outer conductor of input plugs. ● Check for proper ground connection.
Howling when the volume is turned up.	<ul style="list-style-type: none"> ● Turntable and speakers are too close together. 	<ul style="list-style-type: none"> ● Move them farther apart.
Rough or scratchy sound. High range is not clear.	<ul style="list-style-type: none"> ● Stylus of pick-up is worn. ● Stylus is dirty. ● Treble control is too high. 	<ul style="list-style-type: none"> ● Replace. ● Clean. ● Turn treble control down.
Front panel controls function but remote control transmitter does not.	<ul style="list-style-type: none"> ● No batteries in remote control transmitter. ● Batteries have worn out. 	<ul style="list-style-type: none"> ● Insert batteries. ● Replace batteries.
The unit does not function properly, or does not work at all.	<ul style="list-style-type: none"> ● Malfunction of the microcomputer. 	<ul style="list-style-type: none"> ● Unplug the unit, and plug it in again after a while.

Specifications

Power Output:	A-809 105 watts per channel, min. RMS, at 8 ohms, both channels driven from 20 Hz to 20 kHz, with no more than 0.008% Total harmonic distortion.
Dynamic Power:	303 watts at 2 ohms, 235 watts at 4 ohms 155 watts at 8 ohms
Total Harmonic Distortion	0.008% at rated power 0.008% at 1 watt output
Intermodulation Distortion:	0.005% at rated power
Damping Factor:	150 at 8 ohms (1 kHz)
Input Sensitivity/ Impedance:	Phono (MM): 2.5 mV/50 kohms Phono (MC): 160 μ V/130 ohms CD: 150 mV/30 kohms TUNER: 150 mV/30 kohms Tape Play: 150 mV/30 kohms
Output Level/Impedance:	Tape Rec: 150 mV/1.0 kohms (Phono)
Phono Overload:	Phono (MM): 200 mV RMS, at 1 kHz, 0.012% THD.
Tone Control (Vol -20 dB):	BASS: ± 8 dB at 100 Hz TREBLE: ± 8 dB at 10 kHz
High Cut:	6 kHz (6 dB/Octave) (TREBLE min.)
Frequency Response:	CD, Tuner: 2 Hz -50 kHz (+0, -1 dB)
RIAA Deviation:	Phono (MM): ± 0.3 dB, 20 Hz -20 kHz
Subsonic Filter:	20Hz (-3dB, 6dB/Oct)
Signal to Noise Ratio (IHF-A):	Phono (MM): 94 dB (5.0 mV input) Phono (MC): 75 dB (0.5 mV input) CD (DIRECT): 107 dB
Attenuator:	-20 dB
Muting:	$-\infty$
Power Supply:	U.S.A & Canadian models: AC120V, 60 Hz
Dimensions (W x H x D):	455 x 170 x 420 mm 17-15/16" x 6-11/16" x 16-9/16"
Weight:	16.7 kg, 36.8 lbs.

Power Output:	A-807 80 watts per channel, min. RMS, at 8 ohms, both channels driven from 20 Hz to 20 kHz, with no more than 0.008% Total harmonic distortion.
Dynamic Power:	210 watts at 2 ohms, 167 watts at 4 ohms 115 watts at 8 ohms
Total Harmonic Distortion	0.008% at rated power 0.008% at 1 watt output
Intermodulation Distortion:	0.005% at rated power
Damping Factor:	150 at 8 ohms (1 kHz)
Input Sensitivity/ Impedance:	Phono (MM): 2.5 mV/50 kohms Phono (MC): 160 μ V/130 ohms CD: 150 mV/30 kohms TUNER: 150 mV/30 kohms Tape Play: 150 mV/30 kohms
Output Level/Impedance:	Tape Rec: 150 mV/1.0 kohms (Phono)
Phono Overload:	Phono (MM): 180 mV RMS, at 1 kHz, 0.015% THD.
Tone Control (Vol -20 dB):	BASS: ± 8 dB at 100 Hz TREBLE: ± 8 dB at 10 kHz
High Cut:	6 kHz (6 dB/Octave) (TREBLE min.)
Frequency Response:	CD, Tuner: 2 Hz -50 kHz (+0, -1 dB)
RIAA Deviation:	Phono (MM): ± 0.3 dB, 20 Hz -20 kHz
Subsonic Filter:	20Hz (-3dB, 6dB/Oct)
Signal to Noise Ratio (IHF-A):	Phono (MM): 93 dB (5.0 mV input) Phono (MC): 74 dB (0.5 mV input) CD (DIRECT): 107 dB
Attenuator:	-20 dB
Muting:	$-\infty$
Power Supply:	U.S.A & Canadian models: AC120V, 60 Hz
Dimensions (W x H x D):	455 x 170 x 420 mm 17-15/16" x 6-11/16" x 16-9/16"
Weight:	15.5 kg, 34.2 lbs

Specifications and features are subject to change without notice.

ONKYO CORPORATION

International Division: Onarimon Yusen Bldg., 23-5, Nishi-Shimbashi 3-chome, Minato-ku,
TOKYO 105, JAPAN Tel: 03-3432-6987 Fax: 03-3436-6979

ONKYO U.S.A CORPORATION

200 Williams Drive, Ramsey, N.J. 07446, U.S.A.
Tel: 201-825-7950 Fax: 201-825-8150

